

Befestigungs kits zur Nachrüstung für alle handles
Mounting types to retrofit for all handles

ANr. <i>item no.</i>	Serie <i>series</i>	Bezeichnung <i>designation</i>	Bild <i>picture</i>
64896	d-handle	Befestigungs kit Kugelanbindung Ø35 mm <i>mounting kit with ball connection Ø35 mm</i>	
64897	d-handle	Befestigungs kit Flanschanbindung 30 mm x 60 mm <i>mounting kit flange connection 30 mm x 60 mm</i>	
64898	e-handle t-handle c-handle p-handle	Befestigungs kit Flanschanbindung 30 mm x 60 mm <i>mounting kit flange connection 30 mm x 60 mm</i>	

Ausstattungsoptionen mechanisch

Equipment options mechanical

Fernbetätigung mit Handhebel für alle handles Remote control with hand lever for all handles

Fernbetätigung mit Handhebel für mechanische Indexierungen:

- bowdenzugbetätigter, gehärteter Absteckbolzen $\varnothing 16$
- Bowdenzuglänge 2100 mm
- für alle JÄGER-handles geeignet

Gewährleistung für Lebensdauer Bowdenzugbetätigung bei folgenden Bedingungen:





- min. 250.000 Betätigungen (tatsächliche Lebensdauer kann im Einzelfall weit höher liegen)
- max. Umlenkwinkel der Bowdenzugtülle 360° (Summe aller Umlenkwinkel)
- min. Biegeradien $R=100$ mm
- Betätigungskraft am Ende des Handhebel darf 40N nicht übersteigen

Remote control with hand lever for mechanic indexation:

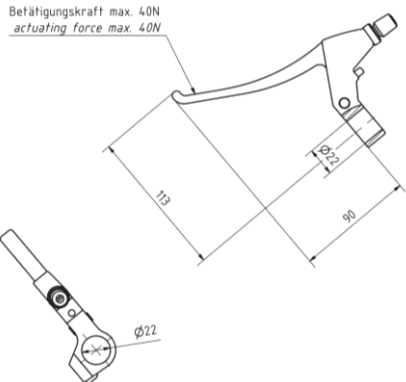
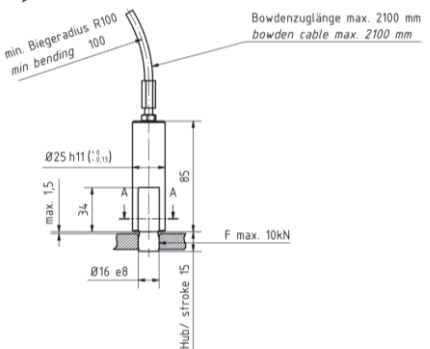

- *hardened positioning bolt operated by bowden cable*
- *bowden cable size 2100 mm*
- *suitable for all JÄGER-handles*

Warranty for durability bowden cable operation under these conditions:

- *min 250.000 activities (actual durability could be much higher in individual cases)*
- *max. bending angle 360° (total of all bending angles)*
- *min. bending radius $R=100$ mm*
- *actuating force of 40N at the end of the lever handle must not be exceeded*

ANr. 65401 item no. 65401	Befestigung an Schaft $\varnothing 22$ mm mounting at the shaft $\varnothing 22$ mm	ANr. 64719 item no. 64719	Befestigung an Axialtaster $\varnothing 22$ mm mounting at the axial button $\varnothing 22$ mm
			
<div style="display: flex; justify-content: space-around;"> <div data-bbox="391 1556 798 2049"> <p>B (1:2)</p>  <p>Betätigungskraft max. 40N actuating force max. 40N</p> <p>$\varnothing 22$</p> <p>$\varnothing 22$</p> </div> <div data-bbox="813 1556 1244 2049"> <p>B</p>  <p>min. Biegeradius R100 min bending 100</p> <p>Bowdenzuglänge max. 2100 mm bowden cable max. 2100 mm</p> <p>$\varnothing 25$ h11 ($^{+0.015}$/$_{-0.010}$)</p> <p>max. 15</p> <p>34</p> <p>A</p> <p>A</p> <p>85</p> <p>F max. 10kN</p> <p>$\varnothing 16$ e8</p> <p>Hub/ stroke 15</p> <p>A-A (1:2)</p>  <p>9.5</p> </div> </div>			

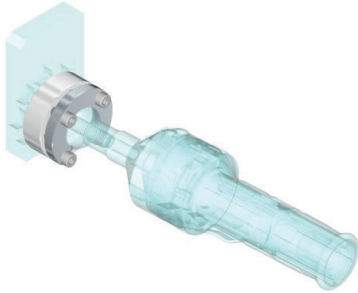
Anbindungen für alle handles
Connections for all handles

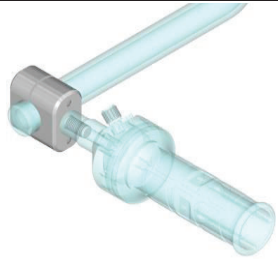
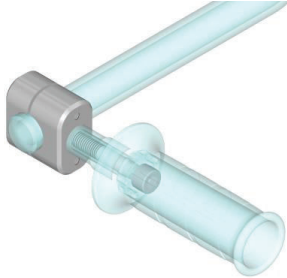
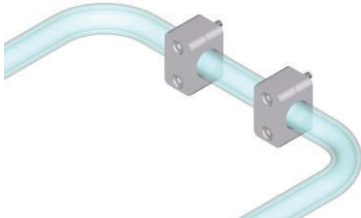
ANr. <i>item no.</i>	Serie <i>series</i>	Bezeichnung <i>designation</i>	Bild <i>picture</i>
57603		<p>Klemmstück D25 D35:</p> <ul style="list-style-type: none"> • Klemmung Ø25 zur Befestigung an Rohrbügel • Kugelanbindung Ø35 zur Befestigung handle • Raumwinkel handle ± 20° einstellbar <p><i>clamp D25 D35:</i></p> <ul style="list-style-type: none"> • <i>clamping Ø25 for mounting to system operate handles</i> • <i>ball connection Ø35 for mounting handle</i> • <i>solid angle handle ± 20° adjustable</i> 	
64875	e-handle t-handle c-handle d-handle p-handle	<p>Klemmstück Flansch D35:</p> <ul style="list-style-type: none"> • Flansch zylindrisch Lochkreis 46mm • Kugelanbindung Ø35 zur Befestigung handle • Raumwinkel handle ± 20° einstellbar <p><i>clamp flange D35:</i></p> <ul style="list-style-type: none"> • <i>flange cylindrical circle diameter 46mm</i> • <i>ball connection Ø35 for mounting handle</i> • <i>solid angle handle ± 20° adjustable</i> 	
68796		<p>Klemmstück D25 D35 2fach:</p> <ul style="list-style-type: none"> • Klemmung Ø25 zur Befestigung an Rohr • 2fach Kugelanbindung Ø35 zur Befestigung von 2 handle an einem Rohr • Raumwinkel handle ± 20° einstellbar <p><i>clamp D25 D35 2fold:</i></p> <ul style="list-style-type: none"> • <i>clamping Ø25 for mounting to tube</i> • <i>2 fold ball connection Ø35 for mounting of 2 handles to a tube</i> • <i>solid angle handle ± 20° adjustable</i> 	
61913		<p>Kit-Rohrschelle D25 S10:</p> <ul style="list-style-type: none"> • 1x Rohrschelle mit Plansenkung für 2x Zylinderschraube M6 • 1x Rohrschelle mit 2x Gewinde M6 und 1x Plansenkung für Zylinderschraube M10 <p><i>Kit-pipe clamp D25 S10:</i></p> <ul style="list-style-type: none"> • <i>1x pipe clamp with counterbore for 2x cylinder head screw M6</i> • <i>1x pipe clamp with 2x threads M6 and 1x counterbore for cylinder head screw M10</i> 	
61915	d-handle	<p>Kit-Rohrschelle D25 M10:</p> <ul style="list-style-type: none"> • 1x Rohrschelle mit Plansenkung für 2x Zylinderschraube M6 • 1x Rohrschelle mit 2x Gewinde M6 und 1x Gewinde für Zylinderschraube M10 <p><i>Kit-pipe clamp D25 M10:</i></p> <ul style="list-style-type: none"> • <i>1x pipe clamp with counterbore for 2x cylinder head screw M6</i> • <i>1x pipe clamp with 2x threads M6 and 1x thread for cylinder head screw M10</i> 	
64909		<p>Kit-Rohrschelle D25 S6:</p> <ul style="list-style-type: none"> • zur Befestigung Griffbügel • 2St. Rohrschellenpaar Ø25 mit Plansenkung für 2x Zylinderschraube M6 <p><i>Kit-pipe clamp D25 S6:</i></p> <ul style="list-style-type: none"> • <i>for mounting system operate handles</i> • <i>2pcs pipe clamp Ø25 with counterbore for 2x cylinder head screw M6</i> 	

Ausstattungsoptionen mechanisch

Equipment options mechanical

Griffrohr d25 G-Form für alle handles
 Tube for handle d25 G-form for all handles

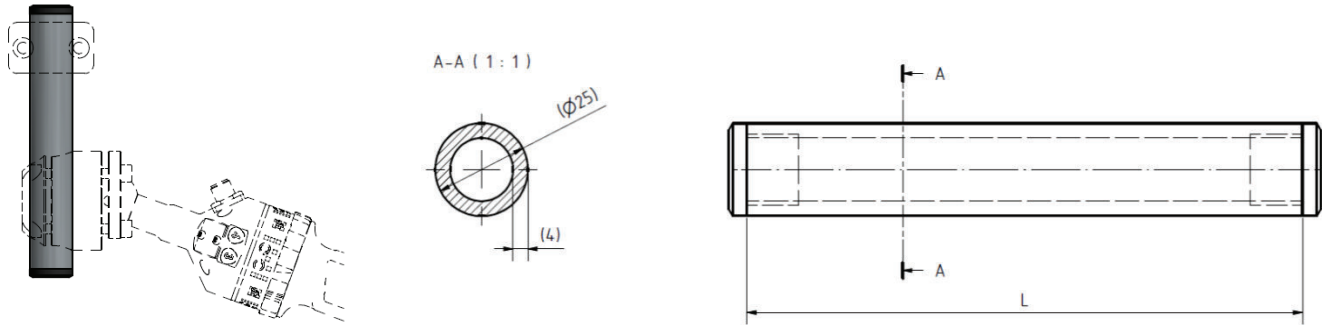

ANr. <i>item no.</i>	L in mm
62983	100
62984	150
62985	200
62989	250
62990	300
62991	350
62992	400
62993	450
62994	500
62995	550
62996	600

Griffbügel d25 L-Form für alle handles
Bow type handle d25 L-form for all handles

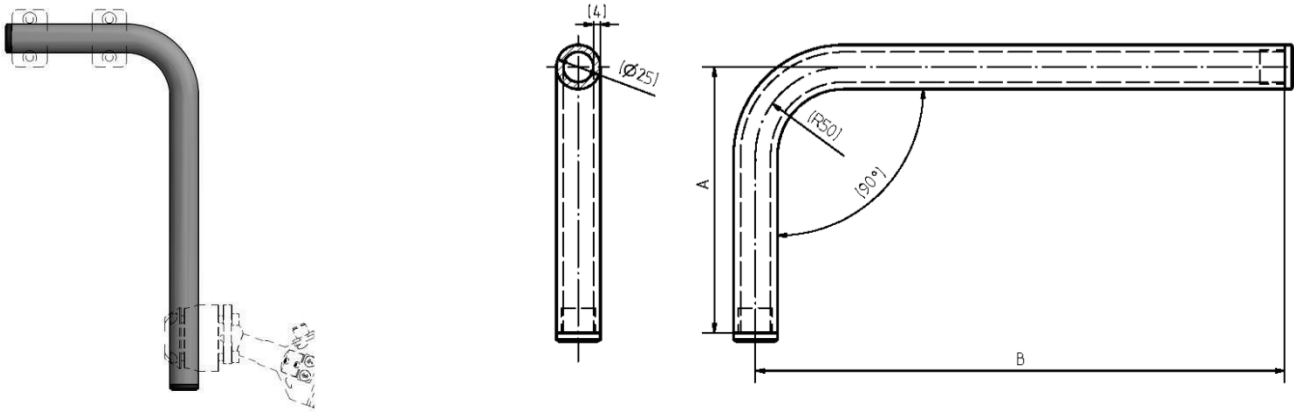

A \ B	150	200	250	300	350	400	450	500	mm
150	62746*	-	-	-	-	-	-	-	ANr. <i>item no.</i>
200	62749	62794	-	-	-	-	-	-	ANr. <i>item no.</i>
250	62780	62790	62880	-	-	-	-	-	ANr. <i>item no.</i>
300	62755	62757	62762	62764	-	-	-	-	ANr. <i>item no.</i>
350	62756*	62760	62881	62798	62769	-	-	-	ANr. <i>item no.</i>
400	62783	62904	62882	62765	62887	62894	-	-	ANr. <i>item no.</i>
450	62787	62795	62797	62766	62770	62896	62899	-	ANr. <i>item no.</i>
500	62788	62771	62775	62883*	62888	62897	62900	62773	ANr. <i>item no.</i>
550	62789	62772*	62767	62886	62889	62898	62901	62902	ANr. <i>item no.</i>
mm	ANr. <i>item no.</i>	ANr. <i>item no.</i>	ANr. <i>item no.</i>	ANr. <i>item no.</i>	ANr. <i>item no.</i>	ANr. <i>item no.</i>	ANr. <i>item no.</i>	ANr. <i>item no.</i>	

Hinweis: ***=Standardabmessungen**, restliche Abmessungen auf Anfrage, Lieferzeit 3 Wochen
*advice: ***=standard dimensions**, other dimensions on request, delivery time 3 weeks*

Ausstattungsoptionen mechanisch

Equipment options mechanical

Griffbügel d25 U-Form für alle handles

Bow type handle d25 U-form for all handles

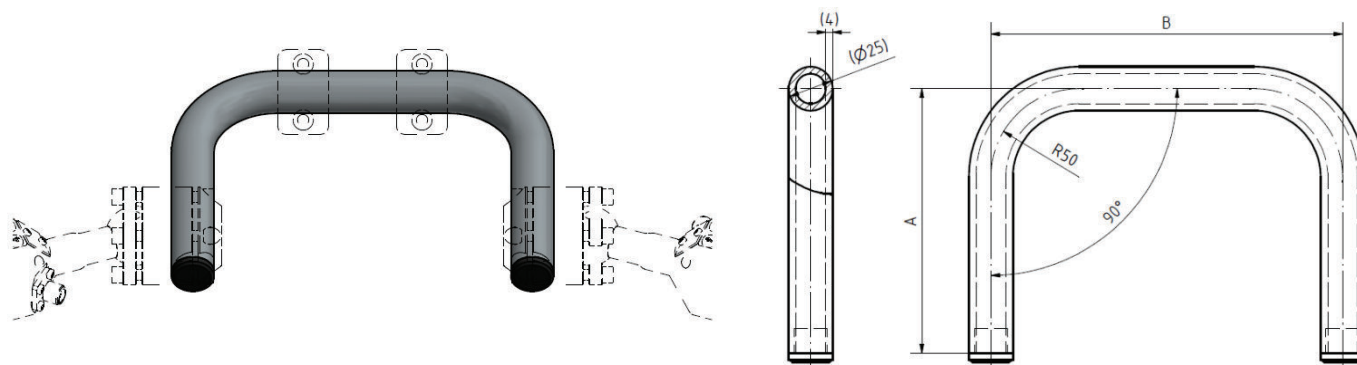

A \ B	200	250	300	350	400	450	500	550	mm
100	63341	63342	63343	63344	63345	63346	63347	63348	ANr. <i>item no.</i>
150	63349*	63350	63351	63352	63353	63354	63355	63356	ANr. <i>item no.</i>
200	63357	63358	63359*	63360	63361	63362	63363	63364	ANr. <i>item no.</i>
250	63365	63366	63367*	63368	63369	63370	63371	63372	ANr. <i>item no.</i>
300	63373*	63374	63375	63376	63377	63378	63379	63380	ANr. <i>item no.</i>
350	63381	63382*	63383	63384*	63385	63386*	63387	63388	ANr. <i>item no.</i>
400	63389	63390	63391	63392	63393	63394	63395	63396	ANr. <i>item no.</i>
450	63397	63398	63399	63400	63401	63402	63403	63404	ANr. <i>item no.</i>
500	63405	63406	63407*	63408	63409	63410	63411	63412*	ANr. <i>item no.</i>
mm	ANr. <i>item no.</i>	ANr. <i>item no.</i>	ANr. <i>item no.</i>	ANr. <i>item no.</i>	ANr. <i>item no.</i>	ANr. <i>item no.</i>	ANr. <i>item no.</i>	ANr. <i>item no.</i>	

Hinweis: *=Standardabmessungen, restliche Abmessungen auf Anfrage, Lieferzeit 3 Wochen

advice: *=standard dimensions, other dimensions on request, delivery time 3 weeks

Zweihand-Auswertebox für e- und t-handle
Two-hand evaluation box for e- and t-handle

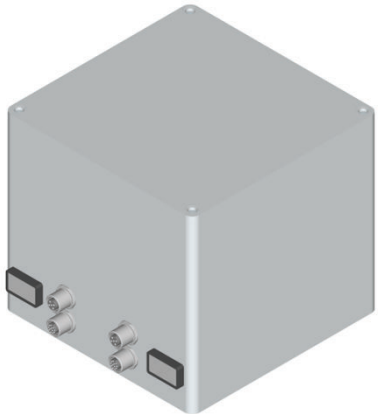
ANr. <i>item no.</i>	Serie <i>series</i>	Beschreibung	designation	Bild <i>picture</i>
76686	e-handle t-handle	Zweihand-Auswertebox Pilz M12: <ul style="list-style-type: none"> für e-und t-handle Gehäuse Kunststoff RAL7035 Auswertegerät Typ P2HZ X1P Fabr. Pilz 2x M12 Buchse 12-pol., 2x M12 Buchse 4-pol. 1x M12 Stecker 12-pol. E-Plan im PDF-Format, deutsch/englisch 	<i>Two hand-evaluation box Pilz M12:</i> <ul style="list-style-type: none"> for e- and t-handle housing RAL 7035 evaluation unit Typ P2HZ X1P brand Pilz 2x M12 socket 12-pin 2x M12 socket 4-pin 1x M12 plug 12-pin e-diagram in PDF-format, German/English 	
76685	e-handle SD t-handle	Zweihand-Auswertebox BR <ul style="list-style-type: none"> für e-handle BR Variante und t-handle Aluminiumgehäuse, schwarz, IP54 -Auswerteeinheit Rexroth Safelogic 2x M12 Buchse 4-pol., 1x M12 Buchse 12-pol 1x M12 Stecker 12-pol. 1x M12 Stecker 4-pol, RS232 E-Plan im PDF-Format, deutsch/englisch 	<i>Two hand-evaluation box BR:</i> <ul style="list-style-type: none"> for e-handle BR variant and t-handle aluminium housing, black, IP54 - evaluation unit Rexroth Safelogic - 2x M12 socket 4-pin - 1x M12 socket 12-pin - 1x M12 plug 12-pin - 1x M12 plug 4-pin, RS232 - e-diagram in PDF-format, german/english 	

Verteilerbox M12 5fach für e- und t-handle
Distribution box M12 5 fold for e- and t-handle

ANr. <i>item no.</i>	Serie <i>series</i>	Beschreibung	designation	Bild <i>picture</i>
78963	für alle e-handle ohne Z im Code <i>For all e-handle without a Z in the code</i>	Verteilerbox M12 5fach: <ul style="list-style-type: none"> Gehäuse 138x60x44, RAL 9005 1x M12 Buchse 12-polig Eingang 5x M12 Stecker 5-polig Ausgänge 	<i>Distribution box M12 5fold:</i> <ul style="list-style-type: none"> housing 138x60x44, RAL 9005 1x M12 socket 12-pin input 5x M12 plug 5-pin outputs 	
61486	für alle e-handle mit Z im Code <i>For all e-handle with a Z in the code</i>	Verteilerbox M12 5fach Z: <ul style="list-style-type: none"> für Zweihandsicherheitsbetätigungen Gehäuse 138x60x44, RAL 9005 1x M12 Buchse 12-polig Eingang 5x M12 Stecker 5-polig Ausgänge 	<i>Distribution box M12 5fold Z:</i> <ul style="list-style-type: none"> for two-hand safety operations housing 138x60x44, RAL 9005 1x M12 socket 12 pin input 5x M12 plug 5-pin outputs 	

Adapterleitung M12 12-polig D-Sub 25 polig für e- und t-handle
Adapter cable M12 12-pin D-Sub 25-pin for e- and t-handle

ANr. <i>item no.</i>	Serie <i>series</i>	Beschreibung	designation	Bild <i>picture</i>
78966	e-handle t-handle	Adapterleitung für e- und t-handle <ul style="list-style-type: none"> Länge 0,5m M12 Buchse gerade 12-polig D-Sub Stecker 25-polig 	<i>Adapter cable for e-and t-handle</i> <ul style="list-style-type: none"> length 0,5m M12 socket straight 12-pin D-Sub plug 25-pin 	

Übersicht Verbindungsleitungen und Verteilerbox für t-handle 12-polig

Overview connection cable and distribution box for t-handle 12 pins

Verbindungsleitung connection cable	Beschreibung description	ANr. item no.	Länge length
Leitung / line C	M12 Buchse 12-polig gerade M12 socket 12-pin angled	58260 58261 58262 61372 58263 58264 58265	1,0m 3,0m 5,0m 7,5m 10,0m 15,0m 20,0m
Leitung / line D	M12 Buchse 12-polig gerade M12 socket 12-pin straight	62123 62124 62125 62126 62134 62135 62136	1,0m 3,0m 5,0m 7,5m 10,0m 15,0m 20,0m
Leitung / line A	M12 Stecker 12-polig gerade M12 plug 12-pin straight M12 Buchse 12-polig gewinkelt M12 socket 12-pin angled	58266 58267 58268 61394 58269 58270 58271	1,0m 3,0m 5,0m 7,5m 10,0m 15,0m 20,0m
Leitung / line B	M12 Stecker 12-polig gerade M12 plug 12-pin straight	58272 58273 58274 58275 58276 58277 58278	1,0m 3,0m 5,0m 7,5m 10,0m 15,0m 20,0m
VB3 Verteilerbox M12 distributor box Zweihand 2 fach two-hand safety	M12 Buchse 12-polig M12 socket 12-pin straight 	61613	



t-handle

66517 THHAZCRR
66518 THHZACRR
71953 THHZAZ
73056 THHZRR
80717 THHZC
80718 THAZC

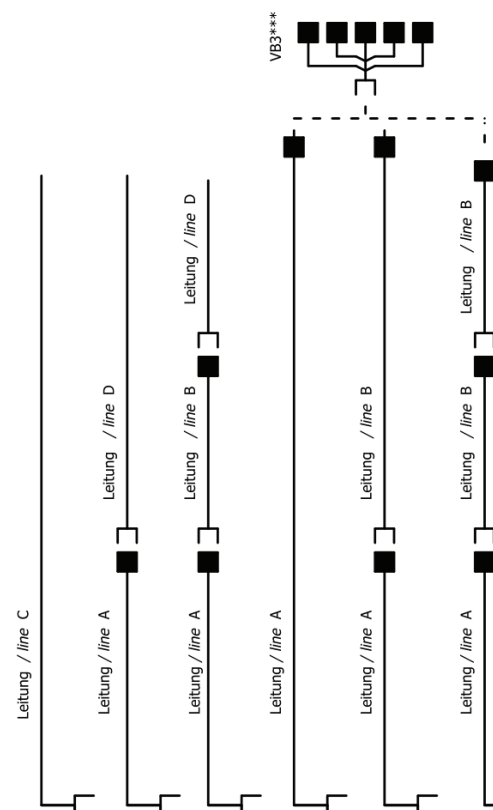

Technische Eigenschaften Leitungen:

- PUR-Außenmantel, Farbe schwarz
- UL/CSA Zulassung
- schleppkettentauglich
- Biegeradius: dynamisch 10x Außen-Ø, statisch 5x Außen-Ø
- Betriebsstrom, -spannung max. 1,5A / max. 30V

Commercial data:

- Zolltarifnummer: 85444290
- Ursprungsland: Deutschland

Technische Spezifikationen:

- PUR-outer sheath, color black
- UL/CSA-certification
- trailing capability
- ben radius: dynamic 10x outer-Ø, static 5x outer-Ø
- operating current / -voltage max. 1,5A / max. 30V

Commercial data:

- customs tariff number: 85444290
- country of origin: Germany

Technical specifications:

- PUR-outer sheath, color black
- UL/CSA-certification
- trailing capability
- ben radius: dynamic 10x outer-Ø, static 5x outer-Ø
- operating current / -voltage max. 1,5A / max. 30V

Commercial data:

- customs tariff number: 85444290
- country of origin: Germany

Übersicht Verbindungsleitungen und Verteilerbox für e-handle
 Overview connection cable and distributor box for e-handle

Verbindungsleitung connector cable	Beschreibung description	ANr. item no.	Länge length
Leitung / line C	M12 Buchse 12-polig gewinkelt M12 socket 12-pin angled	58260 58261 58262 61372 58263 58264 58265	1,0m 3,0m 5,0m 7,5m 10,0m 15,0m 20,0m
Leitung / line D	M12 Buchse 12-polig gerade M12 socket 12-pin straight	62123 62124 62125 62126 62134 62135 62136	1,0m 3,0m 5,0m 7,5m 10,0m 15,0m 20,0m
Leitung / line A	M12 Buchse 12-polig gewinkelt M12 socket 12-pin angled	58266 58267 58268 61394 58269 58270 58271	1,0m 3,0m 5,0m 7,5m 10,0m 15,0m 20,0m
Leitung / line B	M12 Buchse 12-polig gerade M12 socket 12-pin straight	58272 58273 58274 58275 58276 58277 58278	1,0m 3,0m 5,0m 7,5m 10,0m 15,0m 20,0m
VB1 Verteilerbox M12 distributor box	M12 Buchse 12-polig M12 socket 12-pin straight	78963	
VB2 Verteilerbox M12 distributor box Zweihand 1 fach two-hand safety	M12 Buchse 12-polig M12 socket 12-pin straight	78964	

e-handle

71862 EHHRR
 71864 EHHCR
 71865 EHARR
 71866 EHACRR
 71868 EHHACRR
 71870 EHHARR

68182 EHHZRR
 68183 EHAZRR
 68184 EHHZAR

Technical specifications:

- PUR-outer sheath, color black
- UL/CSA-certification
- trailing capability
- Ben radius: dynamic 10x outer-Ø, static 5x outer-Ø
- operating current / -voltage max. 1,5A / max. 30V

Commercial data:

- Zolltarifnummer: 85444290
- country of origin: Germany

Ausstattungsoptionen elektrisch

Equipment options electrical

Übersicht Verbindungsleitungen für t-handle 4-polig

Overview connection cable for t-handle 4 pins

Verbindungsleitung connection cable	Beschreibung description	ANr. item no.	Länge length
Leitung / line L	<p>M12 Buchse 4-polig gewinkelt M12 socket 4-pin angled</p> <p>Offenes Ende open cable end</p>	58283	1,0m
		58284	3,0m
		58285	5,0m
		58293	7,5m
		58294	10,0m
	58295	15,0m	
	58181	20,0m	
Leitung / line M	<p>M12 Buchse 4-polig gerade M12 socket 4-pin straight</p> <p>Offenes Ende open cable end</p>	60175	1,0m
		58279	3,0m
		56807	5,0m
		58280	7,5m
		24307	10,0m
	58281	15,0m	
	58282	20,0m	
Leitung / line J	<p>M12 Buchse 4-polig gewinkelt M12 socket 4-pin angled</p> <p>M12 Stecker 4-polig gerade M12 plug 4-pin straight</p>	58286	1,0m
		58287	3,0m
		58288	5,0m
		58289	7,5m
		58290	10,0m
	58291	15,0m	
	58292	20,0m	
Leitung / line K	<p>M12 Buchse 4-polig gerade M12 socket 4-pin straight</p> <p>M12 Stecker 4-polig gerade M12 plug 4-pin straight</p>	60131	1,0m
		46556	3,0m
		52669	5,0m
		60305	7,5m
		46555	10,0m
	56167	15,0m	
	60605	20,0m	

t-handle

71941 THHZ

71946 THAZ

71917 THH

71922 THA

71939 THHA

Technische Eigenschaften Leitungen:

- PUR-Außenmantel, Farbe schwarz
- UL/CSA Zulassung
- schleppkettentauglich
- Biegeradius: dynamisch 10x Außen-Ø, statisch 5x Außen-Ø
- Betriebsstrom, -spannung max. 1,5A / max. 30V

Kaufmännische Daten:

- Zolltarifnummer: 85444290
- Ursprungsland: Deutschland



Technical specifications:

- PUR-outer sheath, color black
- UL/CSA-certification
- trailing capability
- ben radius: dynamic 10x outer-Ø, static 5x outer-Ø
- operating current / -voltage max. 1,5A / max. 30V

Commercial data:

- customs tariff number: 85444290
- country of origin: Germany

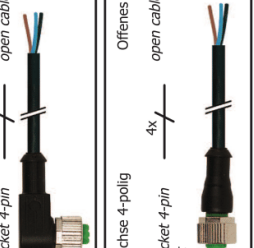
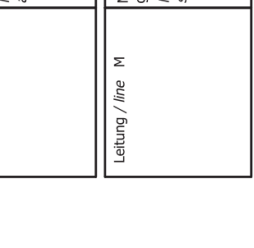
Übersicht Verbindungsleitungen für c-handle
Overview connection cable for c-handle

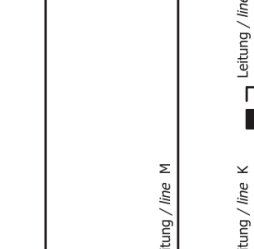
Verbindungsleitung connection cable	Beschreibung description	Anr. item no.	Länge length
Leitung / line L	 <p>M12 Buchse 4-polig gewinkelt M12 socket 4-pin angled</p> <p>Offenes Ende open cable end</p>	58283	1,0m
		58284	3,0m
		58285	5,0m
		58294	7,5m
		58295	10,0m
Leitung / line M	 <p>M12 Buchse 4-polig gerade M12 socket 4-pin straight</p> <p>Offenes Ende open cable end</p>	60175	1,0m
		58279	3,0m
		56807	5,0m
		58280	7,5m
		24307	10,0m
Leitung / line J	 <p>M12 Buchse 4-polig gewinkelt M12 socket 4-pin angled</p> <p>M12 Stecker 4-polig gerade M12 plug 4-pin straight</p>	58286	1,0m
		58287	3,0m
		58288	5,0m
		58289	7,5m
		58290	10,0m
Leitung / line K	 <p>M12 Buchse 4-polig gerade M12 socket 4-pin straight</p> <p>M12 Stecker 4-polig gerade M12 plug 4-pin straight</p>	60131	1,0m
		46556	3,0m
		52669	5,0m
		60305	7,5m
		46555	10,0m
		56167	15,0m
		60605	20,0m



Leitung / line L



Leitung / line M



Leitung / line J



Leitung / line K



Leitung / line K



Leitung / line K



t-handle
58014 c-handle

Technische Eigenschaften Leitungen:

- PUR-Außenmantel, Farbe schwarz
- UL/CSA Zulassung
- schleppkettentauglich
- Biegeradius: dynamisch 10x Außen-Ø, statisch 5x Außen-Ø
- Betriebsstrom, -spannung max. 1,5A / max. 30V

Technische specifications:

- PUR-outer sheath, color: black
- UL/CSA-certification
- trailing capability
- ben radius: dynamic 10x outer-Ø, static 5x outer-Ø
- operating current / -voltage max. 1,5A / max. 30V

Kaufmännische Daten:

- Zolltarifnummer: 85444290
- Ursprungsland: Deutschland

Commercial data:

- customs tariff number: 85444290
- country of origin: Germany

Ausstattungsoptionen elektrisch

Equipment options electrical

Übersicht Verbindungsleitungen und Zweihand-Auswertebox für e-handle 12-polig und t-handle 4-polig
 Overview connection cable and two-hand-evaluation box for e-handle 12 pins and t-handle 4 pins

Verbindungsleitung connection cable	Beschreibung description	ANr. item no.	Länge length
Leitung / line J	M12 Buchse 4-polig gerade M12 socket 4-pin straight	58286	1,0m
	M12 Buchse 4-polig gewinkelt M12 socket 4-pin angled	58287	3,0m
	M12 Buchse 4-polig gerade M12 socket 4-pin straight	58288	5,0m
Leitung / line K	M12 Buchse 4-polig gerade M12 socket 4-pin straight	58289	7,5m
	M12 Buchse 4-polig gerade M12 socket 4-pin straight	58290	10,0m
	M12 Buchse 4-polig gerade M12 socket 4-pin straight	58291	15,0m
	M12 Buchse 4-polig gerade M12 socket 4-pin straight	58292	20,0m
Leitung / line D	M12 Buchse 12-polig gerade M12 socket 12-pin straight	62123	1,0m
	M12 Buchse 12-polig gerade M12 socket 12-pin straight	62124	3,0m
	M12 Buchse 12-polig gerade M12 socket 12-pin straight	62125	5,0m
	M12 Buchse 12-polig gerade M12 socket 12-pin straight	62126	7,5m
	M12 Buchse 12-polig gerade M12 socket 12-pin straight	62134	10,0m
	M12 Buchse 12-polig gerade M12 socket 12-pin straight	62135	15,0m
Leitung / line A	M12 Buchse 12-polig gewinkelt M12 socket 12-pin angled	58266	1,0m
	M12 Buchse 12-polig gewinkelt M12 socket 12-pin angled	58267	3,0m
	M12 Buchse 12-polig gewinkelt M12 socket 12-pin angled	58268	5,0m
	M12 Buchse 12-polig gewinkelt M12 socket 12-pin angled	61394	7,5m
	M12 Buchse 12-polig gewinkelt M12 socket 12-pin angled	58269	10,0m
	M12 Buchse 12-polig gewinkelt M12 socket 12-pin angled	58270	15,0m
Leitung / line B	M12 Buchse 12-polig gerade M12 socket 12-pin straight	58271	20,0m
	M12 Buchse 12-polig gerade M12 socket 12-pin straight	58272	1,0m
	M12 Buchse 12-polig gerade M12 socket 12-pin straight	58273	3,0m
	M12 Buchse 12-polig gerade M12 socket 12-pin straight	58274	5,0m
	M12 Buchse 12-polig gerade M12 socket 12-pin straight	58275	7,5m
	M12 Buchse 12-polig gerade M12 socket 12-pin straight	58276	10,0m
Leitung / line B	M12 Buchse 12-polig gerade M12 socket 12-pin straight	58277	15,0m
	M12 Buchse 12-polig gerade M12 socket 12-pin straight	58278	20,0m
	M12 Buchse 12-polig gerade M12 socket 12-pin straight	58279	1,0m
	M12 Buchse 12-polig gerade M12 socket 12-pin straight	58280	3,0m
	M12 Buchse 12-polig gerade M12 socket 12-pin straight	58281	5,0m
	M12 Buchse 12-polig gerade M12 socket 12-pin straight	58282	7,5m

Leitung / line D

Leitung / line B

Leitung / line B

Leitung / line B

Leitung / line B

Leitung / line D

Leitung / line B

Leitung / line B

Leitung / line B

Leitung / line B

Leitung / line A

Leitung / line A

Leitung / line A

Leitung / line A

Leitung / line B

Leitung / line B

Leitung / line J

Leitung / line J

Leitung / line K

nicht verwenden
do not use

Leitung / line B

Leitung / line B

t-handle 4pol

71941 THHZ

71946 THAZ

e-handle 12pol

68182 EHHZRR

68183 EHAZRR

68184 EHHZAR

ANr.: 76686
item no.: 76686

(XS11) M12 Buchse 4-polig
(XS11) M12 socket 4-pin

Zwei-Hand-Auswertebox
Plz. M12
Variante , Start
Vorwahl Links/Rechts

two hand evaluation box
variant
start signal
preselection chl/ccw

M12 Stecker 12-polig (XS3)
M12 plug 12-pin (XS3)

(XS21) M12 Buchse 4-polig
(XS21) M12 socket 4-pin

(XS2) M12 Buchse 12-polig
(XS2) M12 socket 12-pin

Technische Eigenschaften Leitungen:

- PUR-Außenmantel, Farbe schwarz
- UL/CSA Zulassung
- schleppkettentauglich
- Biegeradius: dynamisch 10x Außen-Ø, statisch 5x Außen-Ø
- Betriebsstrom, -spannung max. 1,5A / max. 30V

Commercial data:

- Kaufmännische Daten:
- Zolltarifnummer: 85444290
- Ursprungsland: Deutschland

Technical specifications:

- PUR-outer sheath, color black
- UL/CSA-certification
- trailing capability
- ben radius: dynamic 10x outer-Ø, static 5x outer-Ø
- operating current / voltage max. 1,5A / max. 30V

Übersicht Verbindungsleitungen und Zweihand-Auswertebox für t-handle 4-polig
Overview connection cable and two-hand-evaluation box for t-handle 4 pins

Verbindungsleitung connection cable	Beschreibung description	ANr. item no.	Länge length
Leitung / line J	M12 Buchse 4-polig gerade M12 socket 4-pin angled	58286 58287 58288 58289 58290 58291 58292	1,0m 3,0m 5,0m 7,5m 10,0m 15,0m 20,0m
Leitung / line K	M12 Stecker 4-polig gerade M12 plug 4-pin straight	60131 46556 52669 60305 46555 56167 60605	1,0m 3,0m 5,0m 7,5m 10,0m 15,0m 20,0m
Leitung / line D	M12 Buchse 12-polig gerade M12 socket 12-pin straight	62123 62124 62125 62126 62134 62135 62136	1,0m 3,0m 5,0m 7,5m 10,0m 15,0m 20,0m
Leitung / line A	M12 Stecker 12-polig gerade M12 plug 12-pin straight	58266 58267 58268 61394 58269 58270 58271	1,0m 3,0m 5,0m 7,5m 10,0m 15,0m 20,0m
Leitung / line B	M12 Stecker 12-polig gerade M12 plug 12-pin straight	58272 58273 58274 58275 58276 58277 58278	1,0m 3,0m 5,0m 7,5m 10,0m 15,0m 20,0m

Verbindungsleitung connection cable	Beschreibung description	ANr. item no.	Länge length
Leitung / line J	M12 Buchse 4-polig gerade M12 socket 4-pin straight	58286 58287 58288 58289 58290 58291 58292	1,0m 3,0m 5,0m 7,5m 10,0m 15,0m 20,0m
Leitung / line K	M12 Stecker 4-polig gerade M12 plug 4-pin straight	60131 46556 52669 60305 46555 56167 60605	1,0m 3,0m 5,0m 7,5m 10,0m 15,0m 20,0m
Leitung / line D	M12 Buchse 12-polig gerade M12 socket 12-pin straight	62123 62124 62125 62126 62134 62135 62136	1,0m 3,0m 5,0m 7,5m 10,0m 15,0m 20,0m
Leitung / line A	M12 Stecker 12-polig gerade M12 plug 12-pin straight	58266 58267 58268 61394 58269 58270 58271	1,0m 3,0m 5,0m 7,5m 10,0m 15,0m 20,0m
Leitung / line B	M12 Stecker 12-polig gerade M12 plug 12-pin straight	58272 58273 58274 58275 58276 58277 58278	1,0m 3,0m 5,0m 7,5m 10,0m 15,0m 20,0m

ANr.: 76686
item no.: 76686

(XS11) M12 Buchse 4-polig
(XS11) M12 socket 4-pin

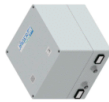

Zwei-Hand-Auswertebox
Platz M12
Variante „Start“
Vorwahl Links/Rechts

two hand evaluation box
variant,
start signal
preselection cw/ccw

M12 Stecker 12-polig (XS3)
M12 plug 12-pin (XS3)



(XS21) M12 Buchse 4-polig
(XS21) M12 socket 4-pin



(XS2) M12 Buchse 12-polig
(XS2) M12 socket 12-pin



nicht verwenden
do not use

t-handle 4pol



71941 THHZ
71946 THAZ

t-handle 4pol



71941 THHZ
71946 THAZ

Technische Eigenschaften Leitungen:
- PUR-Außenmantel, Farbe schwarz
- UL/CSA-Zulassung
- schleppketten-tauglich
- Biegeradius: dynamisch 10x Außen-Ø, statisch 5x outer-Ø
- Betriebsstrom, -spannung max. 1,5A / max. 30V

Commercial data:
- Zolltarifnummer: 85444290
- Ursprungsland: Deutschland

Technical specifications:
- PUR-outer sheath, color black
- UL/CSA-certification
- trailing capability
- ben radius: dynamic 10x outer-Ø, static 5x outer-Ø
- operating current / -voltage max. 1,5A / max. 30V

Ausstattungsoptionen elektrisch

Equipment options electrical

Übersicht Verbindungsleitungen und Verteilerbox für e-handle

Overview connection cable and distribution box for e-handle

Verbindungsleitung connection cable	Beschreibung description	ANr. item no.	Länge length
Leitung / line C	M12 Buchse 12-polig gewinkelt M12 socket 12-pin angled	58260 58261 58262 61372 58263 58264 58265	1,0m 3,0m 5,0m 7,5m 10,0m 15,0m 20,0m
Leitung / line D	M12 Buchse 12-polig gerade M12 socket 12-pin straight	62123 62124 62125 62126 62134 62135 62136	1,0m 3,0m 5,0m 7,5m 10,0m 15,0m 20,0m
Leitung / line A	M12 Buchse 12-polig gewinkelt M12 socket 12-pin angled	58266 58267 58268 61394 58269 58270 58271	1,0m 3,0m 5,0m 7,5m 10,0m 15,0m 20,0m
Leitung / line B	M12 Buchse 12-polig gerade M12 socket 12-pin straight	58272 58273 58274 58275 58276 58277 58278	1,0m 3,0m 5,0m 7,5m 10,0m 15,0m 20,0m
Adapter-Leitung I adapter line I	M12 Buchse 12-polig gerade M12 socket 12-pin straight	78966	0,5m
VB1 Verteilerbox M12 distributor box	M12 Buchse 12-polig gerade M12 socket 12-pin straight	78963	

Verbindungsleitung connection cable	Beschreibung description	ANr. item no.	Länge length
Leitung / line C	Offenes Ende open cable end		
Leitung / line A	Offenes Ende open cable end		
Leitung / line B	M12 Stecker 12-polig gerade M12 plug 12-pin straight		
Leitung / line A	M12 Stecker 12-polig gewinkelt M12 plug 12-pin angled		
Leitung / line B	M12 Stecker 12-polig gerade M12 plug 12-pin straight		
Leitung / line A	D-Sub Stecker 25-polig gerade D-Sub plug 25-pin straight		
Leitung / line B	5x M12 Stecker 5-polig 5x M12 plug 5-pin		

Technische Eigenschaften Leitungen:

- PUR-Außenmantel, Farbe schwarz
- UL/CSA Zulassung
- schleppkettentauglich
- Biegeradius: dynamisch 10x Außen-Ø, statisch 5x Außen-Ø
- Betriebsstrom, -spannung max. 1,5A / max. 30V

Technische Spezifikationen:

- PUR-outer sheath, color black
- UL/CSA certification
- trailing capability
- ben radius: dynamic 10x outer-Ø, static 5x outer-Ø
- operating current / -voltage max. 1,5A / max. 30V

Kaufmännische Daten:

- Zolltarifnummer: 85444290
- Ursprungsland: Deutschland

Commercial data:

- customs tariff number: 85444290
- country of origin: Germany

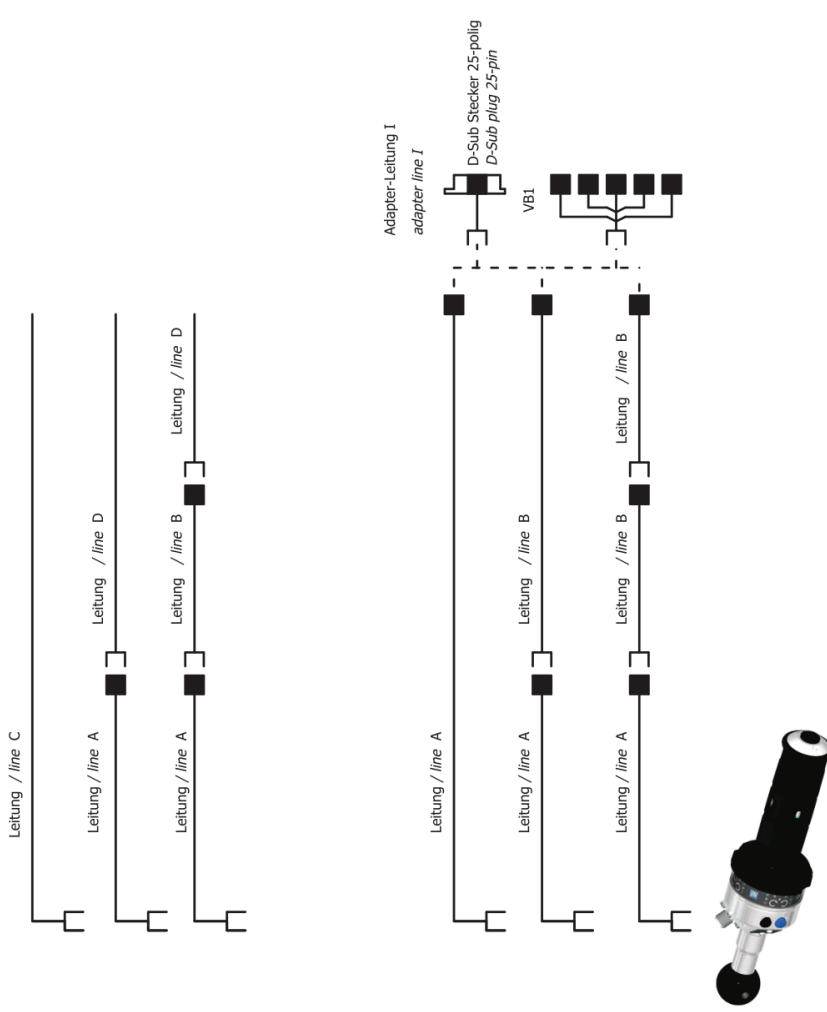

e-handle

- 61964 EHHRRSD
- 61965 EHHCRSD
- 61966 EHARRSD
- 61967 EHACRRSD